

Descrizione / Description / Description

Rubinetto lavabo temporizzato

Self-closing basin tap

Robinet lavabo temporisé

Materiali / Materials / Matériels

Componenti in finitura  
Finishing components  
Composants en finition

Ottone/Brass/Laiton

Componenti torniti  
Machined components  
Composants tournés

Ottone/Brass/Laiton

Guarnizioni  
Gaskets  
Joints

EPDM

Componenti plastica  
Plastic components  
Composants en plastique

POM

Finitura superficiale  
Surface finishing  
Finition de la surface

Conforme/According/Conformément EN 248

In accordo alla EN 9227 in merito all'aggressione salina  
According to EN 9227 regarding saline aggression  
Conformément à la norme EN9227 concernant l'agression saline

Immagine / Picture / Image

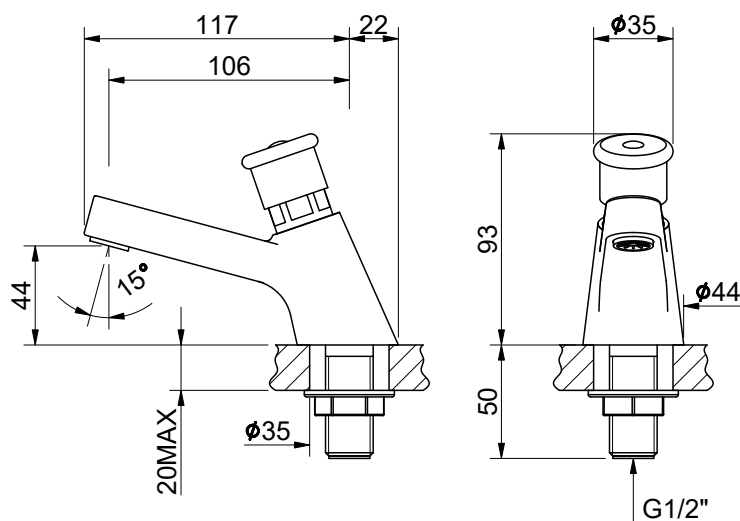

Caratteristiche / Features

 5 - 70 °C

 -

 24 l/min (3 bar)

 Min 0.5 - Max 6 (Recommended 2-4) bar

RUBINETTERIE MCM Int. S.r.l.  
via dell'Acacia, 54/56 - 28021 Borgomanero (NO)  
Tel : +39 0322 843060 - Fax : +39 0322 831613  
E-mail : info@mcmtaps.it - web : www.mcmtaps.it  
P IVA : IT017877240033



100% Made in Italy



15 Years Warranty

Art. 9000

1900000R00CR00000 3