

Descrizione / Description / Description

Lavabo elettronico con premiscelazione

Electronic basin with premixing

Lavabo électronique avec mélange préalable

Materiali / Materials / Matériels

Componenti in finitura
Finishing components
Composants en finition

Ottone/Brass/Laiton

Componenti torniti
Machined components
Composants tournés

Ottone/Brass/Laiton

Guarnizioni
Gaskets
Joints

EPDM

Componenti plastica
Plastic components
Composants en plastique

POM

Finitura superficiale
Surface finishing
Finition de la surface

Conforme/According/Conformément EN 248

In accordo alla EN 9227 in merito all'aggressione salina
According to EN 9227 regarding saline aggression
Conformément à la norme EN9227 concernant l'agression saline

Caratteristiche rubinetti con sensore IR
Features IR sensor taps
Caractéristiques des robinets avec capteur infrarouge

Distanza di esercizio Operating distance Distance de fonctionnement	0.5-10	Cm
Tempo di apertura Opening time Temps d'ouverture	3	sec
Sistema antivandalo Anti-vandal system Système anti-vandalisme	9	sec
Sistema anti legionella Anti legionella system Système anti-légionelles	24	ore hours heures

Caratteristiche / Features

	5 - 70 °C
	12 l/min (3 bar)
	Min 0.5 - Max 6 (Recommended 2-4) bar

	4x1,5V AA Lithium
--	-------------------

Immagine / Picture / Image

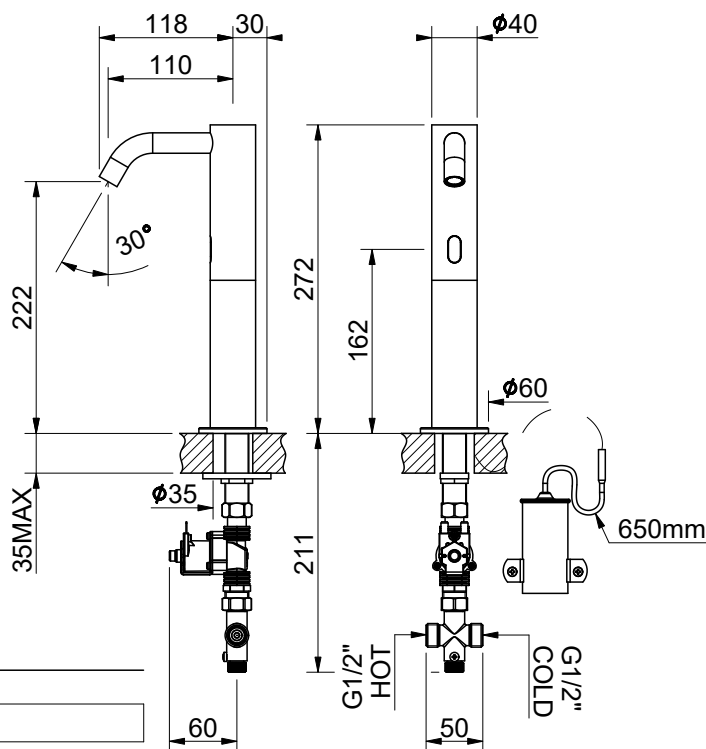

RUBINETTERIE MCM Int. S.r.l.
via dell'Acacia, 54/56 - 28021 Borgomanero (NO)
Tel : +39 0322 843060 - Fax : +39 0322 831613
E-mail : info@mcmtaps.it - web : www.mcmtaps.it
P IVA : IT017877240033



Art. 7035PB MIX

1703507R00CR00000

3



100% Made in Italy